

Large digital displays for distance reading.



DISP-F



Features

DISP-Fx-yz

x = input

- P: process input: 0...10 V and 4(0)...20 mA
- S2: RS-232
- S4: RS-485

y = Digits (4 or 6)

z = Digits height:

- DISP-Fx-y2: 57 mm
- DISP-Fx-y4: 102 mm
- DISP-Fx-y6: 150 mm
- DISP-Fx-y8: 200 mm
- DISP-Fx-y12: 300 mm
- DISP-Fx-y16: 400 mm
- other on request

Application(s) The SENSY's DISP-F is perfectly designed for the following applications:

- Load indication on overhead cranes,
- Weighing indication at long distance,
- Indication of measuring force or torque at a distance.

Function(s)

- Tare by front key or external contact
- Programmation by front key or external contacts

Specifications	DISP-Fx-yz-AC	DISP-Fx-yz-AC48	DISP-Fx-yz-DC	
Type	Large indicator	Large indicator	Large indicator	-
Non-linearity error	<± 0.05**	<± 0.05**	<± 0.05**	% F.S.*
Display	4 / 6 digits	4 / 6 digits	4 / 6 digits	-
Low pass filter	0...25**	0...25**	0...25**	Hz
Service temperature range	0...50***	0...50***	0...50***	°C
Storage temperature range	-20...70	-20...70	-20...70	°C
Temperature coefficient of the sensitivity	<± 0.025**	<± 0.025**	<± 0.025**	% F.S./10°C
Temperature coefficient of zero signal	<± 0.03**	<± 0.03**	<± 0.03**	% F.S./10°C
Power supply	100...240 VAC (40 VA)	48 VAC	11...30 VDC	-
IP rating	IP65****	IP65****	IP65****	-

*F.S. : Full Scale.

** : N.A . for DISP-FS2-yz and DISP-FS4-yz.

*** : option -25...+50°C (internal heating system).

**** : display mounted vertically.

Specifications subject to change without notice.

DISP-F > STANDARD DIMENSIONS

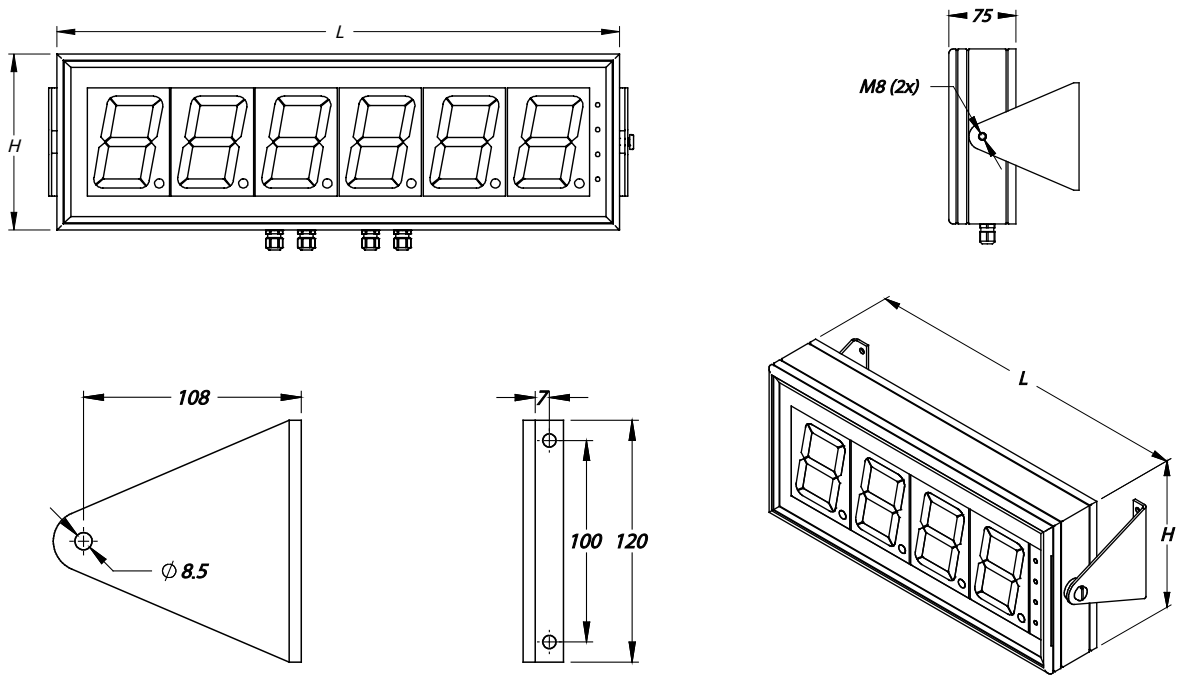

Ref. Item	Digits size		DISP-Fx-yz-AC / DC	DISP-Fx-yz-AC48	H (mm)	Viewing distance (m)
	inches	mm	L (mm) 4 digits / 6 digits	L (mm) 4 digits / 6 digits		
DISP-Fx-y2	2.25	57	279.5 / 376	376 / 504	154.5	25
DISP-Fx-y4	4	102	434 / 616	616 / 824	195.5	50
DISP-Fx-y6	6	150	580 / 820	820 / 1060	246	75
DISP-Fx-y8	8	200	750 / 1072	1072 / 1395	290	100
DISP-Fx-y12	12	300	1058 / 1540	1540 / 2022	408	140
DISP-Fx-y16	16	400	1368 / 2020	2020 / 2672	515	200

Options

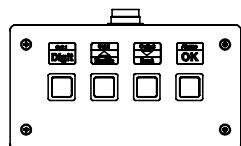

OPTION 1: PROGRAMMATION BOX (REF: PBOX-4B)

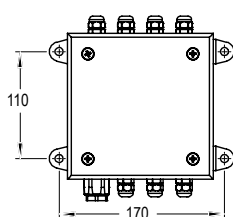

OPTION 2: JUNCTION BOX (REF: JBOX-FP)

Terminals

S2 / S4:

RS-232

RS-485

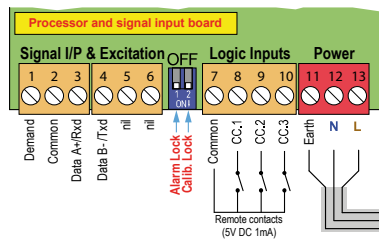

PROCESS INPUT:

0...10 V

4(0)...20 mA

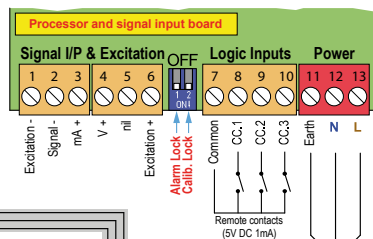

General use

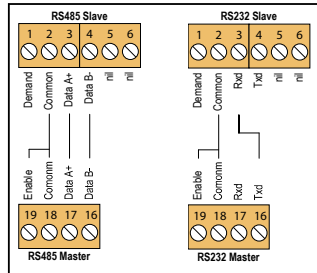

Specific use with PAX family*

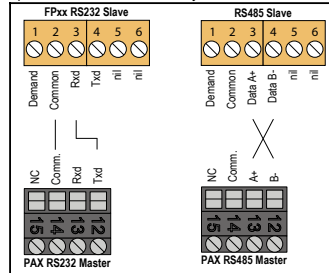

*PAX family: INDI-PAX, IND-BOY, DISP-PAXDP, DISP-BOYDP, DISP-SUMD, CRANE-BOY, CRANE-SUMD

Dimensions in mm

