

## Speed sensor - RPM sensor

FGL 01620



### Application fields

- Wind power generation
- Marine engines
- Large gear units
- Water turbines
- Safety systems

### Benefits

- Wide speed sensing range
- Robust design
- Contactless, wear-free
- Large air gap feasible
- Multifunctional sensing options

## Working principle

The speed sensor series FGL01620 has been developed for very flexible use: Extremely low speed -near full stop- can be detected as well as highspeed rotations up to 20kHz frequency.

This wide range allows the FGL01620 type to be applied in multiple applications: industrial turbines, heavy industry gearbox units, windpower generators and large-scale engines. The robust stainless steel design makes the FGL01620 a preferred sensor in offshore and marine purposes.

The sensor detects ferromagnetic materials such as gear wheels and can handle modules of 1 to 6.

Our development competence is shown by the specifications for the air gap: The permitted system distance between the sensor and the gearwheel is shown in table below, it is larger than average and therefore -combined with a fine thread pitch of 1mm- simple installation is ensured.

The square-wave signal voltage is available via a push-pull output stage. Sensor signal is extremely stable due to differential measurement principle.

*Smart Sensor option:* The FGL01620 speed sensor has been designed as a basic measuring unit. On request it offers optional functions to be integrated such as temperature and/or vibration sensing.

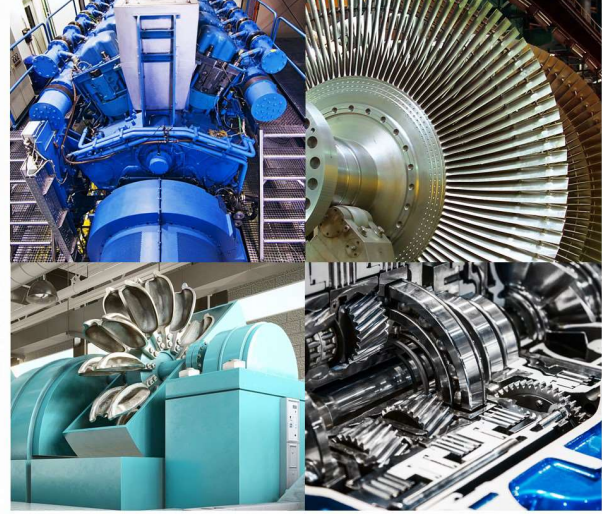

## Technical data sensor FGL 01620

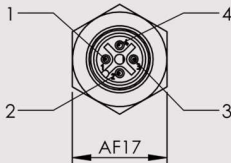
Characteristics	Technical data
Power supply $U_B$	18...32VDC accord. DNV CG-0339 (min. voltage 10VDC)
Current consumption	8...20mA (accord. Load)
Signal output characteristics	$I_{\max} = \pm 20\text{mA}$ ; $U_{\text{low}} < 2.5\text{VDC}$ ; $U_{\text{high}} > U_B - 3.5\text{VDC}$
Frequency range	0.05Hz...20kHz
Operating temperature	-40°C ... +125°C
Electrical insulation	500V each wire against housing
Short circuit proof / inverse polarity	Yes
EMC / ESD	accord. DNV CG-0339
Pole wheel	Ferromagnetic tooth width >10mm (gearwheel module $M = 1...6$ )
Housing	Non-magnetic, stainless steel
Protection degree acc. to DIN 40050	Sensor head IP68 Connector side IP67
Vibration	4G accord. DNV CG-0339
Connection terminals (M12x1)	1 = 24VDC 2 = signal OUT 3 = GND 4 = NC (sensor) 
Certificates	Class approval DNV

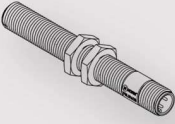
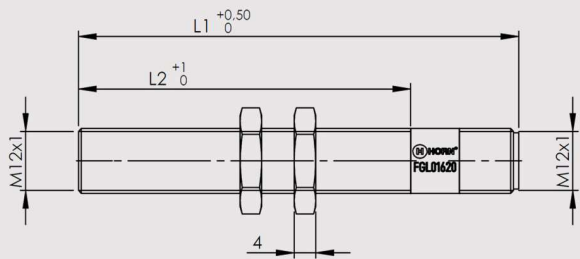
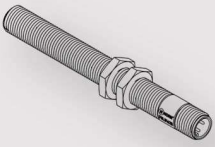
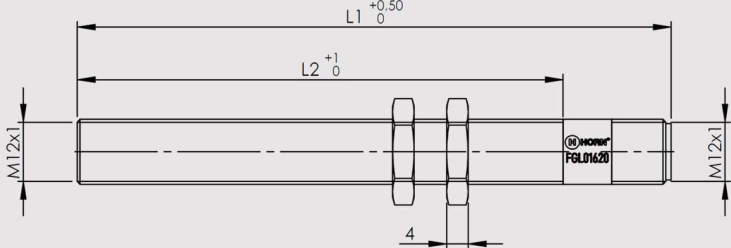

Version	Drawing
<p>FGL 01620-1 Shaft length L1 = 90mm Thread length L2 = 70mm</p> 	
<p>FGL 01620-2 Shaft length L1 = 109mm Thread length L2 = 90mm</p> 	

Optional LED status indication on request.

Output signal characteristics

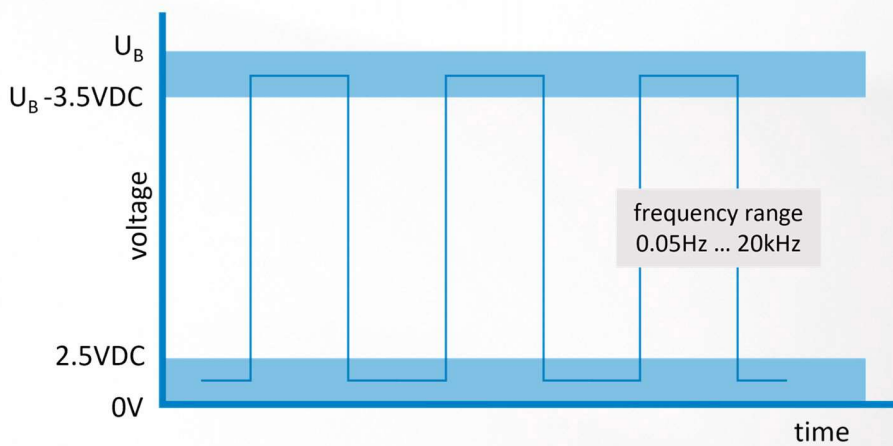

Single channel sensor, the output displays the rotational speed as a single track frequency signal.

Air gap definition

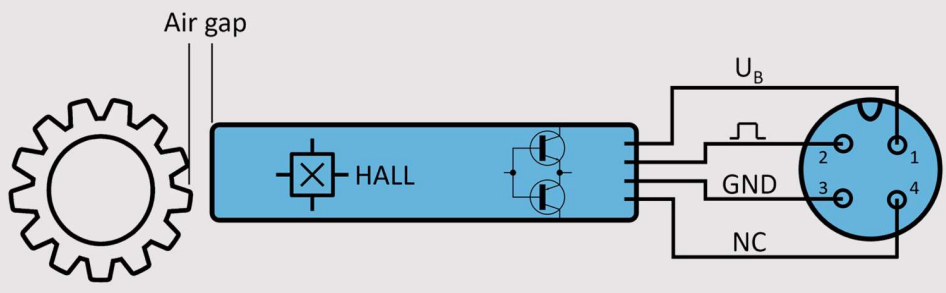
Schematics	Module / Air gap
	<p>M1 → approx. 0.2 ... 1.0mm  M2 → approx. 0.2 ... 2.5mm  M3 → approx. 0.2 ... 3.5mm  M4 → approx. 0.2 ... 4.5mm  M5 → approx. 0.2 ... 4.5mm  M6 → approx. 0.2 ... 4.5mm</p>

## Cable type KSG03252-xx

Flexible, silicone- and halogen-free control cable with high mechanical strength. Resistant against chemicals, hydrolysis, oil, diesel oil and microbes. The cable meets UL and CSA (UL10493/20549; cULus) requirements. Offers very good EMC-properties because of shielded version.

Length xx: 5, 10, 15, 20m



Characteristics	Technical data connector
Connector type	M12, female, straight
Number of pins	4
Pin assignment	1 BN, 2 WH, 3 BU, 4 BK
Coding of	A
Rated voltage/current	250V / 4A
Resistance	≤ 5mΩ
Insulation resistance	>=10 <sup>8</sup> Ω
Ambient temperature	-40°C...+90°C (fixed mounting)
Shielding	with shielding
Degree of protection	IP 67 (mounted)
Standards	IEC 61076-2-101

Characteristics	Technical data cable
Cable outer diameter	5.1mm
Cable-jacket material	PUR
Cable-jacket colour	BK, similar RAL9005
Wire cross-section	4 x 0.34mm <sup>2</sup>
Bending radius (fixed)	5x cable diameter
Wire colours	BN, WH, BU, BK
Shielding	Yes
Halogen-free	yes
Special features	flame retardant, seawater resistant, recyclable, LABS free, RoHs compliant, acid- and alkali resistant, ozone resistant, UV resistant, hydrolysis proof, drag chain-adapted, torsion resistant, welding sparks resistant, halogen free, silicone free, oil resistant

## Ordering structures

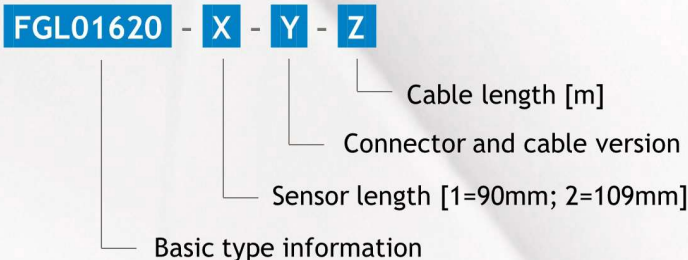

## Options and related products

The present sensor is preferably used in combination with engine control systems. Dr. E. Horn develops and produces control systems and the corresponding indicating instruments according to customer specifications.

In case of using FGL01620 in safety-level environment (SIL-level required), please do not hesitate to contact us.

## Product marking

Dr. E. Horn GmbH & Co. KG

Type: FGL01620-X

Made in Germany



Dr. E. Horn offers portable tachometers, speed indicators and programmable converters for limit and alert settings.

## Dr. E. Horn GmbH & Co KG

Max-Planck-Str. 34 · 71116 Gärtringen · Germany

Fon +49 7034 270 24-0

Fax +49 7034 270 24-69

info@dr-horn.org

www.dr-horn.org

